

TINA2-M

~30° medium beam optimized for CREE XP-E.
Assembly with holder and installation tape.

TECHNICAL SPECIFICATIONS:

Dimensions	Ø 16 mm
Height	9.5 mm
Fastening	tape, pin
Colour	black
Box size	451 x 241 x 298 mm
Box weight	8.3 kg
Quantity in Box	4140 pcs
ROHS compliant	yes ⓘ



MATERIAL SPECIFICATIONS:

Component	Type	Material	Colour
TINA2-XP-M	Lens	PMMA	clear
TINA2-HLD-BLK	Holder	PC	black
TINA-TAPE3	Tape	PU tape	black

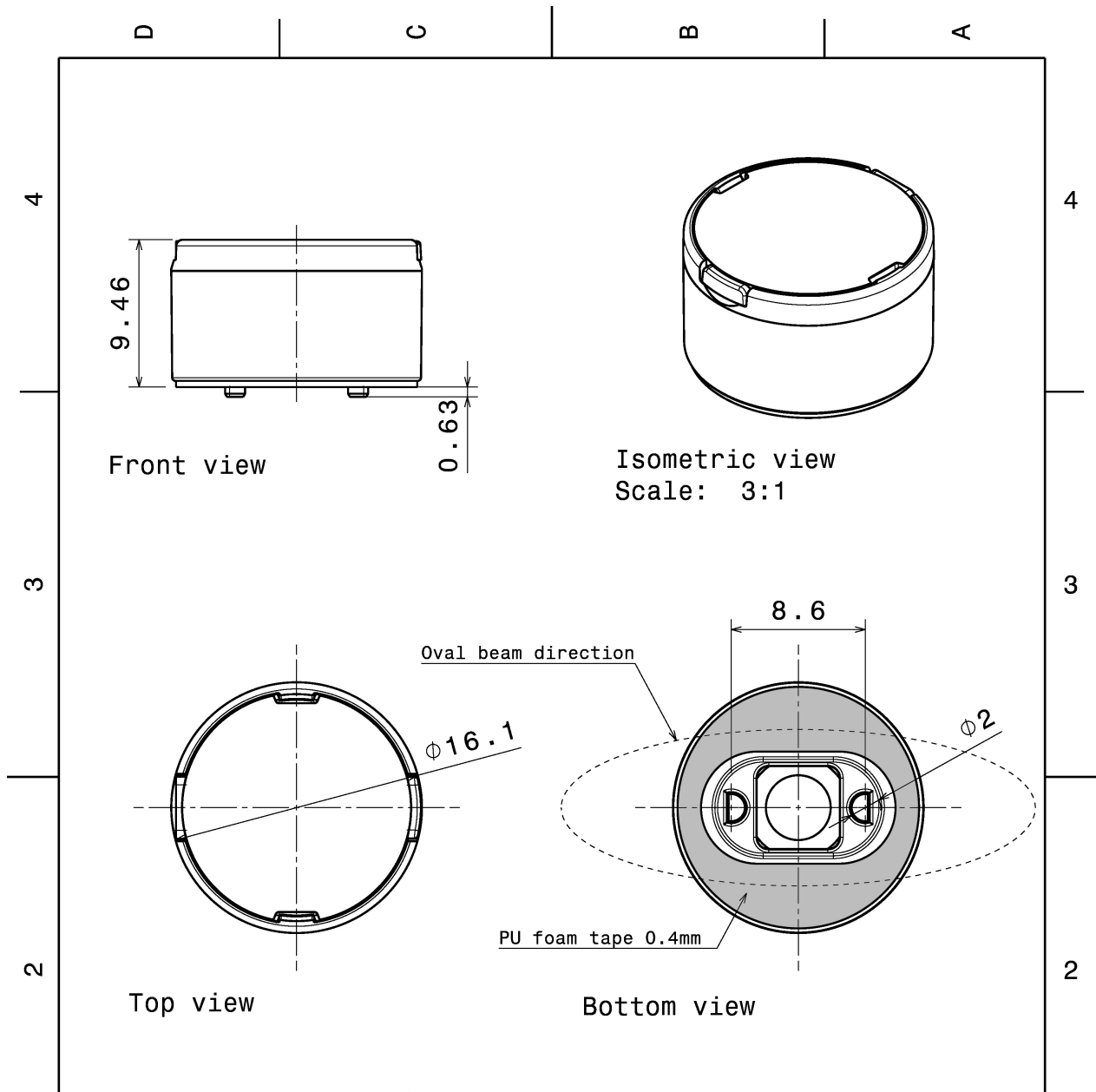

INDEX	PART NO	DESCRIPTION	MATERIAL	COLOUR
1	-	TINA2-lens	PMMA	
2	C12372	TINA2-HLD-BLK	PC	black

Tolerances if not otherwise shown
According to DIN ISO 2768-1
Linear measures:
Up to 30mm class M, otherwise class C.
According to DIN ISO 2768-2
Form and position: class L

LEDiL LediL Oy
Salorankatu 10
FIN 24240 SALO
Finland

THIRD ANGLE PROJECTION:

DRAWING TITLE
TINA2 series datasheet

This drawing is the property of LEDiL Oy. It may not be reproduced, copied or communicated without a written agreement with LEDiL Oy.

SIZE	PART NUMBER
A4	-

SCALE	3:1	WEIGHT	1,3 g	SHEET	1/1
-------	-----	--------	-------	-------	-----

PHOTOMETRIC DATA (MEASURED):



LED XB-H
FWHM 31.0°
Efficiency 85 %
Peak intensity 2.700 cd/lm
Required components:

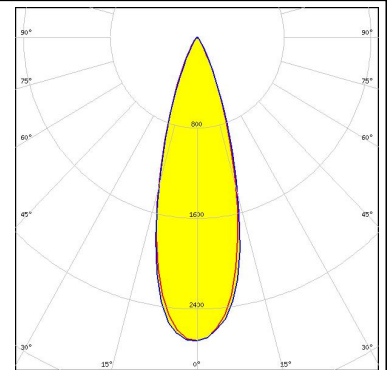
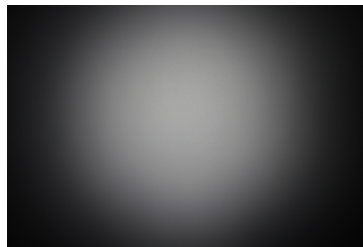

LED XQ-E
FWHM 29.0°
Efficiency 84 %
Peak intensity 3.200 cd/lm
Required components:

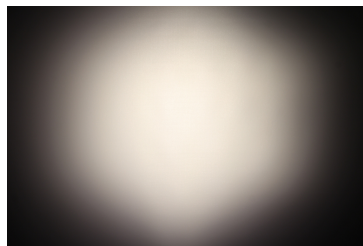

LED LUXEON CZ
FWHM 28.0°
Efficiency 89 %
Peak intensity 3.400 cd/lm
Required components:

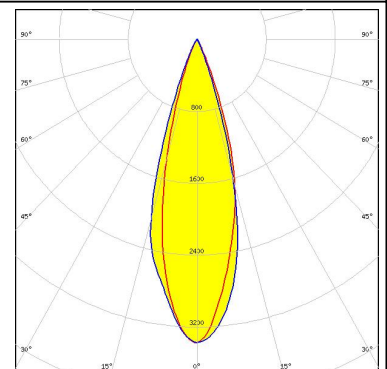
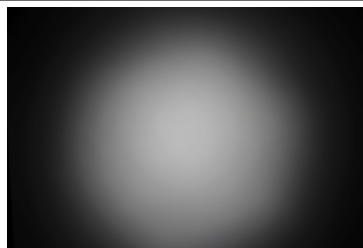

LED LUXEON TX
FWHM 30.0°
Efficiency 86 %
Peak intensity 2.800 cd/lm
Required components:

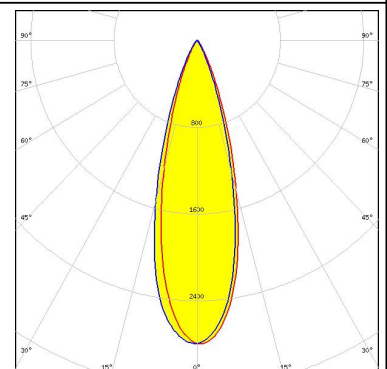
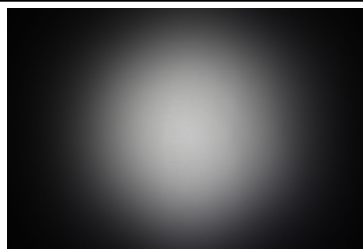

PHOTOMETRIC DATA (MEASURED):



LED LUXEON Z ES
FWHM 31.0°
Efficiency 88 %
Peak intensity 3.200 cd/lm
Required components:

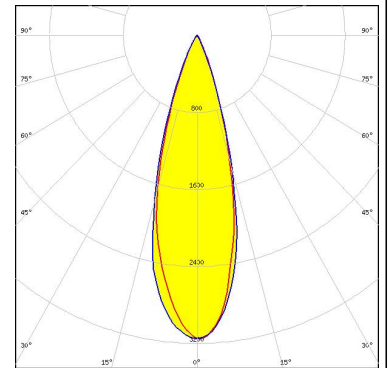
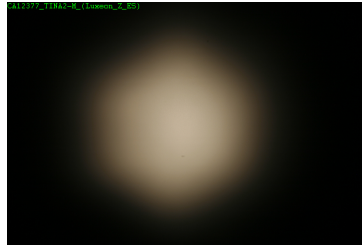

LED NVSxx19B/NVSxx19C
FWHM 29.0°
Efficiency 85 %
Peak intensity 2.700 cd/lm
Required components:

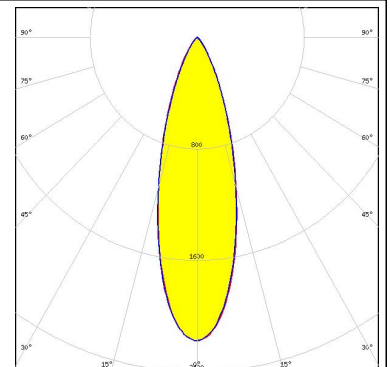
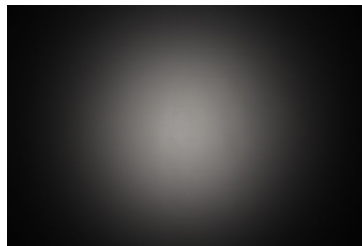

LED NWSx229A
FWHM 26.0°
Efficiency 86 %
Peak intensity 2.200 cd/lm
Required components:

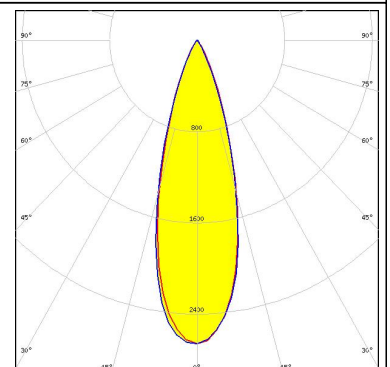

LED Oslon Square EC
FWHM 30.0°
Efficiency 85 %
Peak intensity 2.200 cd/lm
Required components:

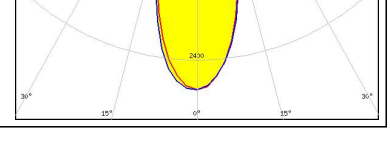
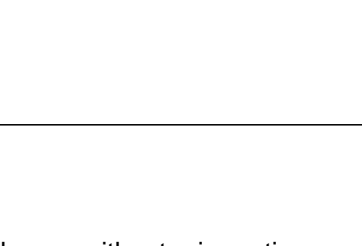

PHOTOMETRIC DATA (MEASURED):

OSRAM
Opto Semiconductors

LED Oslon Square PC
FWHM 29.0°
Efficiency 86 %
Peak intensity 2.400 cd/lm
Required components:

OSRAM
Opto Semiconductors

LED Oslon SSL 150
FWHM 30.0°
Efficiency 87 %
Peak intensity 2.500 cd/lm
Required components:

OSRAM
Opto Semiconductors

LED Oslon SSL 80
FWHM 31.0°
Efficiency 84 %
Peak intensity 2.280 cd/lm
Required components:

OSRAM
Opto Semiconductors

LED SFH 4715S
FWHM 28.0°
Efficiency %
Peak intensity cd/lm
Required components:

PHOTOMETRIC DATA (MEASURED):

OSRAM
Opto Semiconductors

LED SFH 4725S

FWHM 27.0°

Efficiency %

Peak intensity cd/lm

Required components:

PHOTOMETRIC DATA (SIMULATED):



LED XQ-E HI
 FWHM 29.0°
 Efficiency 90 %
 Peak intensity 3.200 cd/lm
 Required components:

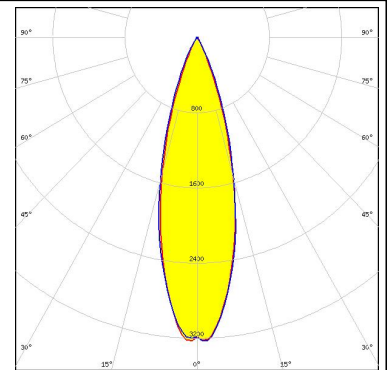

LED LUXEON C
 FWHM 30.0°
 Efficiency 93 %
 Peak intensity 2.900 cd/lm
 Required components:

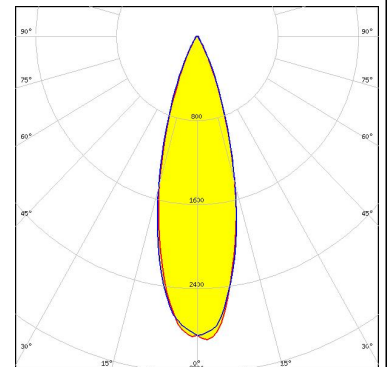

LED LUXEON IR Compact
 FWHM 29.0°
 Efficiency 83 %
 Peak intensity 0.000 cd/lm
 Required components:



LED NFSx757G
 FWHM 29.0°
 Efficiency 90 %
 Peak intensity 3.010 cd/lm
 Required components:

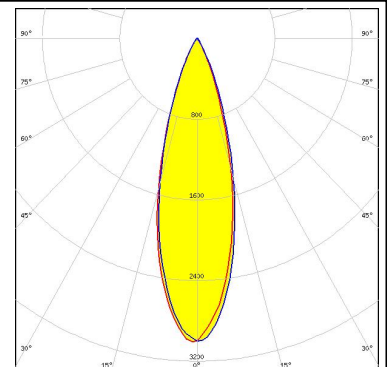

PHOTOMETRIC DATA (SIMULATED):

OSRAM
Opto Semiconductors

LED Duris S5 (2 chip)
FWHM 29.0°
Efficiency 92 %
Peak intensity 2.980 cd/lm
Required components:

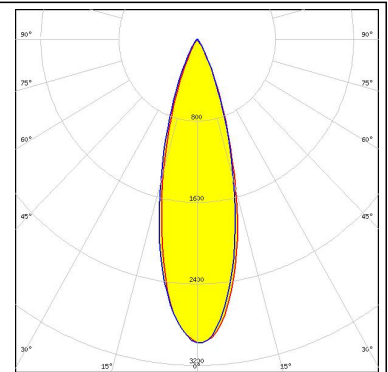
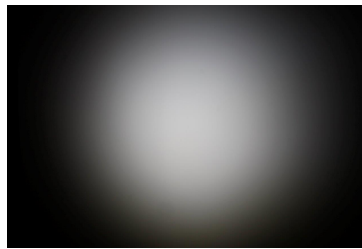

OSRAM
Opto Semiconductors

LED Oslon Black Flat
FWHM 28.0°
Efficiency 91 %
Peak intensity 3.500 cd/lm
Required components:

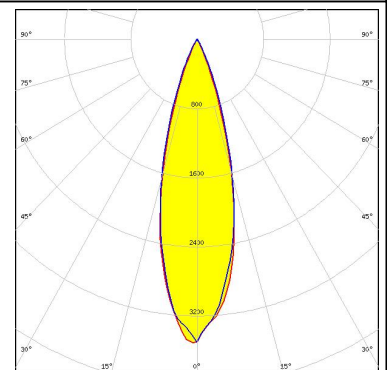

OSRAM
Opto Semiconductors

LED Oslon Square Flat
FWHM 29.0°
Efficiency 89 %
Peak intensity 3.130 cd/lm
Required components:

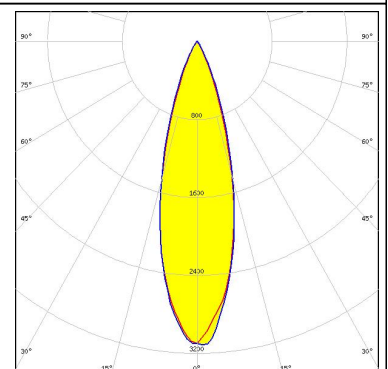
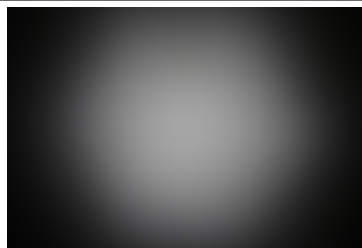

OSRAM
Opto Semiconductors

LED Oslon Square Gen3
FWHM 29.0°
Efficiency 90 %
Peak intensity 2.935 cd/lm
Required components:

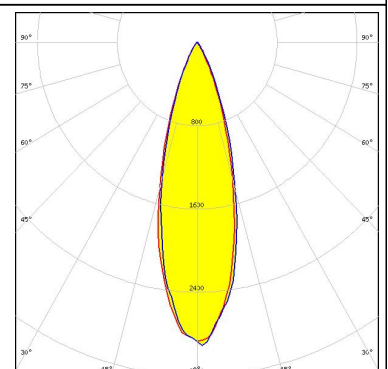

PHOTOMETRIC DATA (SIMULATED):

OSRAM
Opto Semiconductors

LED SFH 4770S
FWHM 27.0°
Efficiency 85 %
Peak intensity 3.200 cd/lm
Required components:

OSRAM
Opto Semiconductors

LED Synios P2720 1 mm
FWHM 27.0°
Efficiency 91 %
Peak intensity 3.560 cd/lm
Required components:

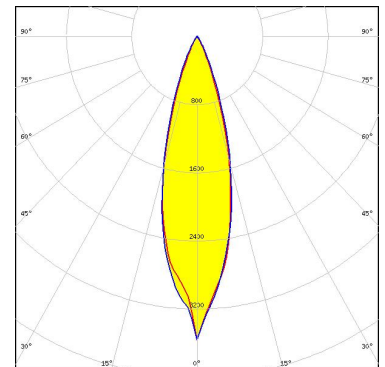

OSRAM
Opto Semiconductors

LED Synios P2720 1/2 mm
FWHM 29.0°
Efficiency 93 %
Peak intensity 3.370 cd/lm
Required components:

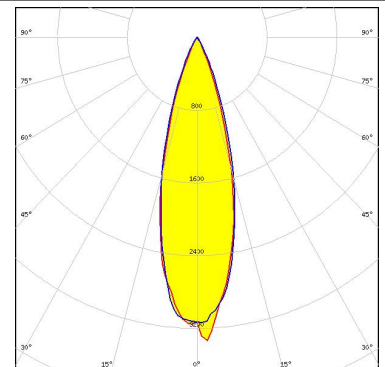

OSRAM
Opto Semiconductors

LED Synios P2720 1/4 mm
FWHM 28.0°
Efficiency 91 %
Peak intensity 3.140 cd/lm
Required components:

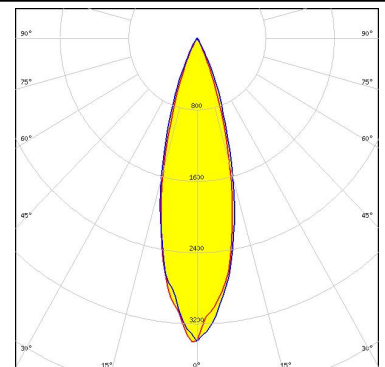

PHOTOMETRIC DATA (SIMULATED):

SAMSUNG

LED LH181B
FWHM 29.0°
Efficiency 90 %
Peak intensity 3.000 cd/lm
Required components:

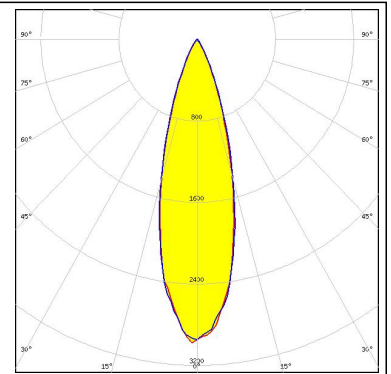

GENERAL INFORMATION:

NOTE: The typical beam angle will be changed by different color, chip size and chip position tolerance. The typical total beam angle is the full angle measured where the luminous intensity is half of the peak value.

MATERIALS:

As part of our continuous research and improvement processes, and to ensure the best possible quality and availability of our products, LEDiL reserves the right to change material grades without notice.

PRODUCT DATA USER AGREEMENT AND DISCLAIMER:

The measured data in the provided downloadable LEDiL Product Datasheets and Mechanical 2D-Drawings is rounded and provided as reference for planning. LEDiL Oy's optical specifications have been verified by conducting performance testing of the products in accordance with the company's quality system. The reported data are averaged results of multiple measurements with typical variation. LEDiL Oy reserves the right to without prior notification make changes and improvements to its products.

LEDiL Oy assumes neither warranty, nor guarantee nor any other liability of any kind for the contents and correctness of the provided data. The provided data has been generated with highest diligence but the provided data may in reality not represent the complete possible variation range of all intrinsic parameters. Therefore, in certain cases a deviation from the provided data could occur.

LEDiL Oy reserves the right to undertake technical changes of its products without further notification which could lead to changes in the provided data. LEDiL Oy assumes no liability of any kind for the possible deviation from any provided data or any other damage resulting from the usage of the provided data.

The user agrees to this disclaimer and user agreement with the download or usage of the provided files.

LEDiL Oy

Joensuunkatu 13
FI-24240 SALO
Finland

LEDiL Inc.

228 West Page Street
Suite D
Sycamore IL 60178
USA

Local sales and technical support

[www.ledil.com/
where_to_buy](http://www.ledil.com/where_to_buy)

Shipping locations

Salo, Finland
Hong Kong, China

Distribution Partners

[www.ledil.com/
where_to_buy](http://www.ledil.com/where_to_buy)