

**DATA SHEET**

# OLS910: Hermetic Surface Mount Photovoltaic Optocoupler

## Features

- Performance guaranteed over  $-55\text{ }^{\circ}\text{C}$  to  $+125\text{ }^{\circ}\text{C}$  ambient temperature range
- 1500 V<sub>DC</sub> electrical isolation
- High open-circuit voltage
- High short-circuit current
- Small hermetic surface mount package
- High reliability and rugged construction
- Isolated voltage source
- Offers 100% high reliability screenings

## Description

The OLS910 consists of a pair of LEDs that are optically coupled to a dielectrically isolated photovoltaic diode array, packaged in a small hermetic Leadless Chip Carrier (LCC). When the LED is energized, the infrared emission is detected by the photovoltaic array and a DC output voltage is generated. This electrically isolated voltage can be used to drive the gates of Metal Oxide Semiconductor (MOS) devices.

Device mounting is achieved with reflow soldering or conductive epoxies.

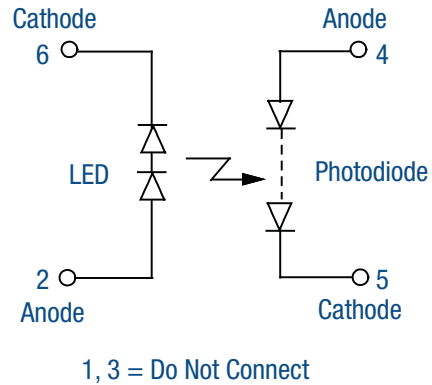

**Figure 1. OLS910 Block Diagram**

Figure 1 shows the OLS910 functional block diagram. Table 1 provides the OLS910 absolute maximum ratings. Table 2 provides the OLS910 electrical specifications.

Figures 2 through 6 illustrate the OLS910 typical performance characteristics. Figure 7 shows the OLS910 package dimensions.

**Table 1. OLS910 Absolute Maximum Ratings (Note 1)**

Parameter	Symbol	Minimum	Maximum	Units
<b>Coupled</b>				
Input to output isolation voltage	V <sub>DC</sub>	-1500	+1500	V
Storage temperature range	T <sub>STG</sub>	-65	+150	°C
Operating temperature range	T <sub>A</sub>	-55	+125	°C
Mounting temperature range (3 minutes maximum)			+240	°C
<b>Input Diode</b>				
Average input current	I <sub>DD</sub>		50	mA
Peak forward current (≤1 ms duration)	I <sub>F</sub>		100	mA
Reverse voltage	V <sub>R</sub>		5	V
Power dissipation	P <sub>D</sub>		100	mW
<b>Output Detector</b>				
Forward voltage	V <sub>F</sub>		20	V
Reverse voltage	V <sub>R</sub>		200	V

**Note 1:** Exposure to maximum rating conditions for extended periods may reduce device reliability. There is no damage to the device with only one parameter set at the limit and all other parameters set at or below their nominal value. Exceeding any of the limits listed here may result in permanent damage to the device.

**CAUTION:** Although this device is designed to be as robust as possible, electrostatic discharge (ESD) can damage this device. This device must be protected at all times from ESD. Static charges may easily produce potentials of several kilovolts on the human body or equipment, which can discharge without detection. Industry-standard ESD precautions should be used at all times.

**Table 2. OLS910 Electrical Specifications (Note 1)**  
**(T<sub>A</sub> = -55 °C to +125 °C, Unless Otherwise Noted)**

Parameter	Symbol	Test Condition	Minimum	Typical	Maximum	Units
Open circuit voltage	V <sub>OC</sub>	I <sub>F</sub> = 10.0 mA	7.5	13.0		V
Short circuit current	I <sub>SC</sub>	I <sub>F</sub> = 10 mA	-7	-20		μA
Input:						
Forward voltage	V <sub>F</sub>	I <sub>F</sub> = 10 mA, T <sub>A</sub> = 25 °C I <sub>F</sub> = +10 mA, T <sub>A</sub> = -55 °C I <sub>F</sub> = 10 mA, T <sub>A</sub> = 125 °C	2.4 +2.8 2.2	2.8	3.2 +3.6 3.0	V V V
Reverse breakdown voltage	B <sub>VR</sub>	I <sub>R</sub> = 10 μA	5			V
Output leakage current (Note 2)	I <sub>L_O</sub>	R <sub>H</sub> ≤ 50%, 1500 V <sub>DC</sub> , T <sub>A</sub> = 25 °C, Duration = 1 s			1	μA
Time:						
Turn on	t <sub>ON</sub>	I <sub>F</sub> = 10 mA, PW = 100 μs, f = 1 kHz, C = 15 pf, T <sub>A</sub> = 25 °C, R <sub>L</sub> = 10 MΩ		60		μs
Turn off	t <sub>OFF</sub>	t <sub>ON</sub> = 0 V to 90% t <sub>OFF</sub> = V <sub>OC</sub> to 10%			1	μs

**Note 1:** Performance is guaranteed only under the conditions listed in the above table.

**Note 2:** Measured between pins 1, 2, and 6 shorted together, and pins 3, 4, and 5 shorted together. T<sub>A</sub> = 25°C and duration = 1 s.

**Typical Performance Characteristics**

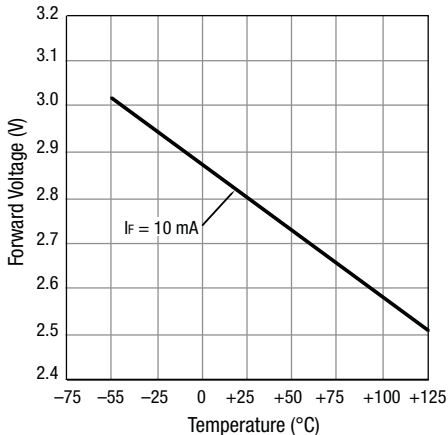

**Figure 2. LED Forward Voltage vs Temperature**

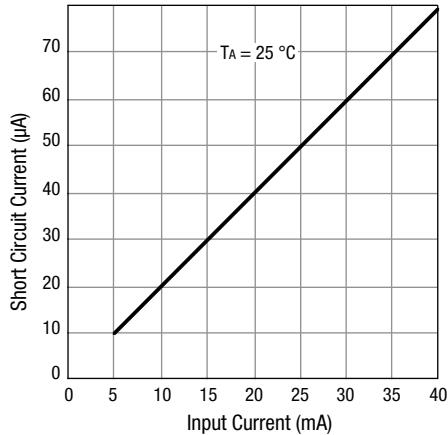

**Figure 3. Short Circuit Current vs Input Current**

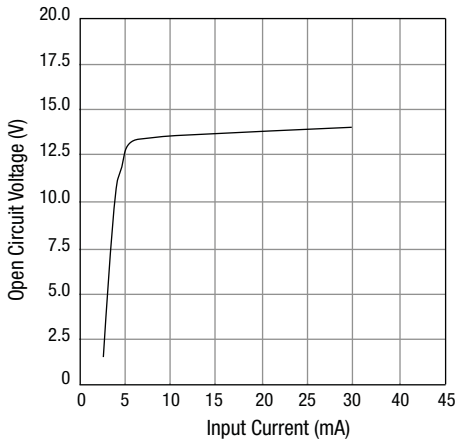

**Figure 4. Open Circuit Voltage vs Input Current**

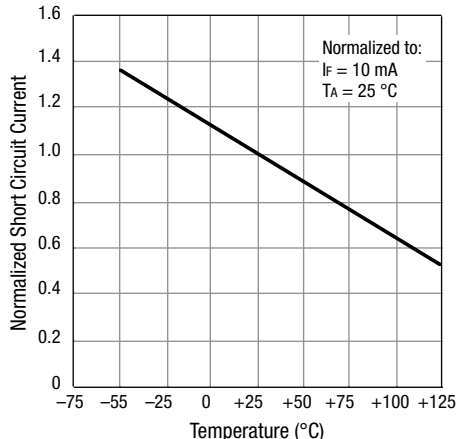

**Figure 5. Normalized Short Circuit Current vs Temperature**

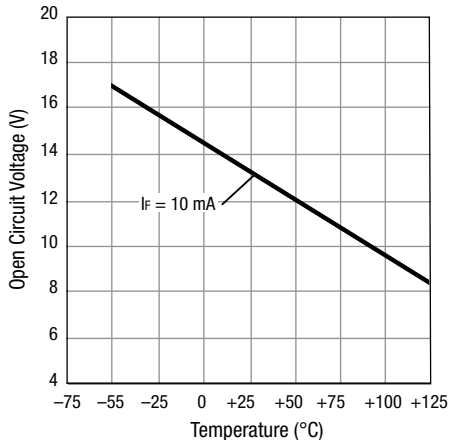

**Figure 6: Open Circuit Voltage vs Temperature**

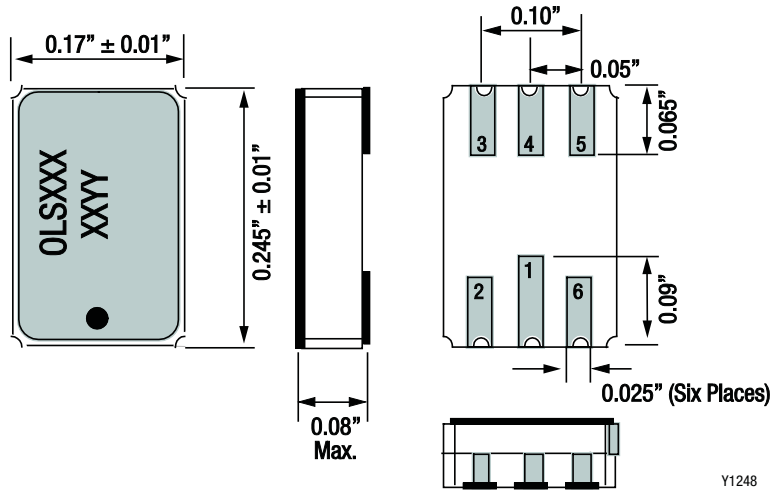

Figure 7. OLS910 Package Dimensions

**Ordering Information**

Model Name	Manufacturing Part Number
OLS910: Hermetic Surface Mount Photovoltaic Optocoupler	OLS910

Copyright © 2012-2015, 2017 Isolink, Inc. All Rights Reserved.

Information in this document is provided in connection with Isolink, Inc. ("Isolink"), a wholly-owned subsidiary of Skyworks Solutions, Inc. These materials, including the information contained herein, are provided by Isolink as a service to its customers and may be used for informational purposes only by the customer. Isolink assumes no responsibility for errors or omissions in these materials or the information contained herein. Isolink may change its documentation, products, services, specifications or product descriptions at any time, without notice. Isolink makes no commitment to update the materials or information and shall have no responsibility whatsoever for conflicts, incompatibilities, or other difficulties arising from any future changes.

No license, whether express, implied, by estoppel or otherwise, is granted to any intellectual property rights by this document. Isolink assumes no liability for any materials, products or information provided hereunder, including the sale, distribution, reproduction or use of Isolink products, information or materials, except as may be provided in Isolink Terms and Conditions of Sale.

THE MATERIALS, PRODUCTS AND INFORMATION ARE PROVIDED "AS IS" WITHOUT WARRANTY OF ANY KIND, WHETHER EXPRESS, IMPLIED, STATUTORY, OR OTHERWISE, INCLUDING FITNESS FOR A PARTICULAR PURPOSE OR USE, MERCHANTABILITY, PERFORMANCE, QUALITY OR NON-INFRINGEMENT OF ANY INTELLECTUAL PROPERTY RIGHT; ALL SUCH WARRANTIES ARE HEREBY EXPRESSLY DISCLAIMED. ISOLINK DOES NOT WARRANT THE ACCURACY OR COMPLETENESS OF THE INFORMATION, TEXT, GRAPHICS OR OTHER ITEMS CONTAINED WITHIN THESE MATERIALS. ISOLINK SHALL NOT BE LIABLE FOR ANY DAMAGES, INCLUDING BUT NOT LIMITED TO ANY SPECIAL, INDIRECT, INCIDENTAL, STATUTORY, OR CONSEQUENTIAL DAMAGES, INCLUDING WITHOUT LIMITATION, LOST REVENUES OR LOST PROFITS THAT MAY RESULT FROM THE USE OF THE MATERIALS OR INFORMATION, WHETHER OR NOT THE RECIPIENT OF MATERIALS HAS BEEN ADVISED OF THE POSSIBILITY OF SUCH DAMAGE.

Customers are responsible for their products and applications using Isolink products, which may deviate from published specifications as a result of design defects, errors, or operation of products outside of published parameters or design specifications. Customers should include design and operating safeguards to minimize these and other risks. Isolink assumes no liability for applications assistance, customer product design, or damage to any equipment resulting from the use of Isolink products outside of stated published specifications or parameters.

Isolink is a trademark of Isolink Inc. in the United States and other countries. Skyworks and the Skyworks symbol are trademarks or registered trademarks of Skyworks Solutions, Inc., in the United States and other countries. Third-party brands and names are for identification purposes only, and are the property of their respective owners.